

CAPP®

D E N M A R K

CR1512



USER MANUAL

CONTENTS

1. Product Description	1
1.1 Introduction	
1.2 Intended Use	
1.3 Salient Features	
1.4 Standard Accessories	
1.5 Technical Specifications	
2. Safety Precautions	4
3. Installation	6
3.1 Location	
3.2 Connecting Power Adaptor	
4. Standard Parts Listing	7
5. User Interface and Display	8
6. Rotor Installation	10
6.1 Rotors and Accessories	
6.2 Rotor Removing & Replacing Process	
6.3 Balancing the Rotor	
7. Operating the Centrifuge	13
7.1 Switch ON the Centrifuge	
7.2 Setting Speed and Time	
7.3 Switching to RCF Display	
7.4 Short Spin Centrifugation	
7.5 Opening Centrifuge Lid in Power Failure	
7.6 Imbalance detection	
8. Remote Operation & Programming	17
8.1 System Requirement	
8.2 Installing GUI Software	
8.3 Connecting USB cable	
8.4 Understanding the GUI and its Operation	
8.5 Data Logger	
9. Maintenance and cleaning	26
10. Troubleshooting	27
11. Warranty Statement	29
12. Product Disposal	31

1. PRODUCT DESCRIPTION

1.1 INTRODUCTION

Congratulation! You are using the table top genius high speed micro centrifuge. The product is equipped with a maintenance free drive, a large display & a simple interface for silent & efficient operation for daily lab usage. This next generation micro centrifuge can be operated via USB with facility of data logger and comes with a host of safety features including imbalance detection. The programmable centrifuge can deliver upto 15000 rpm and can process volumes upto 12 x 2 ml microtubes. It can also accept different types of microtubes including 0.2 ml, 0.4 ml & 0.5 ml microtube, when used with the reduction adapters supplied along with the unit. A separate strip rotor is also available for using 2 x 8 PCR strips.

1.2 INTENDED USE

Centrifuge is used in various laboratories to separate particles from suspension or even macromolecules from solutions according to their density. The different biological substances that are usually separated by centrifugation are microbial cells, mammalian cells, organelles, proteins, DNA and RNA. It is majorly used in research laboratories.

NOTE: *Before using the centrifuge, please read this user manual carefully. This user manual is intended to assist with the operation and care of the unit only and not its repair. For repair please contact the supplier.*

<i>For you reference, make a note of serial number, date of purchase and supplier here.</i>	
<i>Serial No.:</i>	<i>Purchase Date:</i>
<i>Supplier:</i>	

1. PRODUCT DESCRIPTION

1.3 SALIENT FEATURES

Centrifuge has following features:

1. Imbalance detector with auto cutoff.
2. Large back light digital LCD display.
3. High centrifugal force which delivers 15000 RPM/15596 x g RCF.
4. USB port for remote terminal control capability.
5. Remote operation with data logger.
6. Lid safety interlock & auto lid open
7. Convenient and easy user interface.
8. Quick acceleration and deceleration time.
9. One touch short spin centrifugation.
10. Last run memory feature.
11. Emergency lid release during power cutoff.
12. Countdown timer.
13. Automatic internal diagnosis & error display.
14. Speed setting by RPM/RCF mode.
15. Fully autoclaveable high strength aluminum rotor with metal lid.
16. Small footprint.

1.4 STANDARD ACCESSORIES

1. Power supply (Adaptor) & USB cable
2. 12 slots microtube rotor (Pre-installed)
3. T - Allen wrench
4. Adaptors for 0.4/0.5 ml tubes (set of 12)
5. Adaptors for 0.2 ml tubes (set of 12)
6. Software CD
7. Product user manual & warranty card

1. PRODUCT DESCRIPTION

1.5 TECHNICAL SPECIFICATIONS

Motor Type	Brushless DC Motor
Maximum Speed	15000 rpm
Run Time	30 secs to 999 mins & infinite mode
Speed Setting	Variable 500 - 15000 rpm
Speed Accuracy	± 100 rpm
Maximum Volume	12 x 2 ml (microtubes)
Maximum RCF	15596 x g
Ambient Temperature	5 - 40 °C
Permissible Relative Moisture	<80%
Air Pressure	80 to 106 kPa
Acceleration Time	20 \pm 2 seconds
Deceleration Time	28 \pm 2 seconds
Noise Level	<60 dB
Size (L x B x H)	262 x 230 x 131 mm
Weight	4.04 Kg (with rotor)
Input Power	100 - 240 VAC, 50 / 60 Hz, 2.5A
Output Power	24VDC, 6A
Power Consumption	72W

2. SAFETY PRECAUTIONS

- Never use the centrifuge in any manner not specified in this manual.
- Equipment used in any manner not specified in this manual or by the manufacturer, the protection provided by the equipment may be impaired.
- Never move the centrifuge while the rotor is spinning.
- The rotor and the rotor lid must always be securely fastened. If the centrifuge makes unusual noise during operation, the rotor or rotor lid fitment needs to be checked. Switch OFF the device immediately by pressing STOP, check fitment & fasten it well.
- The rotors must be loaded symmetrically. Each tube should be counter balanced by another tube of same weight.
- Do not use centrifuge or rotor that have not been correctly installed or damaged.
- Repairs must only be performed by authorized service technician.
- Only use recommended original rotors and spare parts for best result & product safety.
- Centrifuge may be used for the specified applications only. It must not be operated in a hazardous or flammable environment and must not be used to centrifuge explosive or highly reactive substances. Also do not place the potential hazardous material within the clearance area/envelope. 
- If liquids are spilled on the rotor or rotor chamber, the centrifuge must be cleaned carefully and properly before being used again.
- Prior to centrifugation, the tubes should be visually inspected for material damage. Damaged tubes may not be centrifuged. This is because broken tubes can, in addition to sample loss, create imbalance which can result in further damage to the centrifuge and accessories.
- The capacity of 12 x 2 ml must not be exceeded as it is the maximum capacity. Do not use liquid with density higher than 1.2g/ml for full load operation.

2. SAFETY PRECAUTIONS

- Do not lean on the equipment. It may damage the equipment or harm the operator.
- When moving the centrifuge from a cold room to a normal room, run the centrifuge for 30 minutes beforehand in the cold room to avoid condensation. Alternately, allow it to warm up in lab for at least three hours, but do not plug in the centrifuge in order to prevent possible damage by condensation.
- Be sure to close the tubes lid tightly prior to centrifugation. Open tubes lid can be torn off during centrifugation and can damage the rotor lid or centrifuge.
- Rotors and rotor lids are high-graded components which are subject to extreme mechanical strain. Even slight scratches and tears can lead to serious internal material damage. Ensure to check rotor for any signs of damage before use. Rotor & rotor lid showing visible signs of corrosion or mechanical damage should not be used.
- Do not fill tubes while they are in the rotor. Liquid spillage may harm the device.
- For safety we have provided protective earthing with power supply. Make sure power supply is earthed.
- In the event of contamination caused by aggressive agents, the rotor must be cleaned immediately using a natural cleaning liquid. This is particularly important for the bores of the tubes. If any damage is seen, contact the service technician.
- Before using cleaning or decontamination methods, other than those stipulated by the manufacturer, contact the manufacturer to ensure that the intended method will not damage the centrifuge.
- The power adaptor given with centrifuge unit is designed to use for that particular centrifuge. Do not use any other power adaptor.

3. INSTALLATION

The table top genius is supplied in a box. Open the box, then remove the packaging and gently take the centrifuge out of the box. Before 1st time usage, open the centrifuge & ensure to remove all packaging from the rotor chamber & ensure rotor is firmly tightend. The user manual and accessories should be kept with the centrifuge. Please keep all packaging in safe storage for atleast 2 year for warranty purpose.

Note: Instruction for transportation after delivery to the Responsible Body is based in deal to customer.

3.1 LOCATION & MOUNTING

Place the centrifuge on a flat and leveled surface; ensure that the four feet of this centrifuge stand in the surface firmly. Avoid installing on a slippery surface or surface prone to vibration.

1. Ideal ambient temperature is $20^{\circ}\text{C} \pm 5^{\circ}\text{C}$; avoid placing the centrifuge in direct sunlight.
2. Keep clearance of at least 10 cm on both sides and at least 30 cm behind it to guarantee the cooling efficiency.
3. Keep away from heat or water to avoid sample temperature issues or centrifuge failures.
4. Do not place the centrifuge so that it become difficult to operate the device.

3.2 CONNECTING POWER ADAPTOR

1. Connect one side of power adaptor to rear side of centrifuge and other to supply as shown in the figure below.
2. Rotate clockwise the adaptor nut to tighten the adaptor with the centrifuge. Ensure the power switch is OFF while connecting the power adaptor.

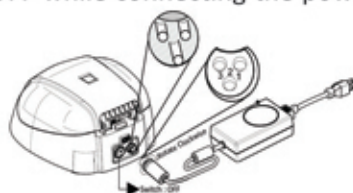

4. STANDARD PARTS LISTING

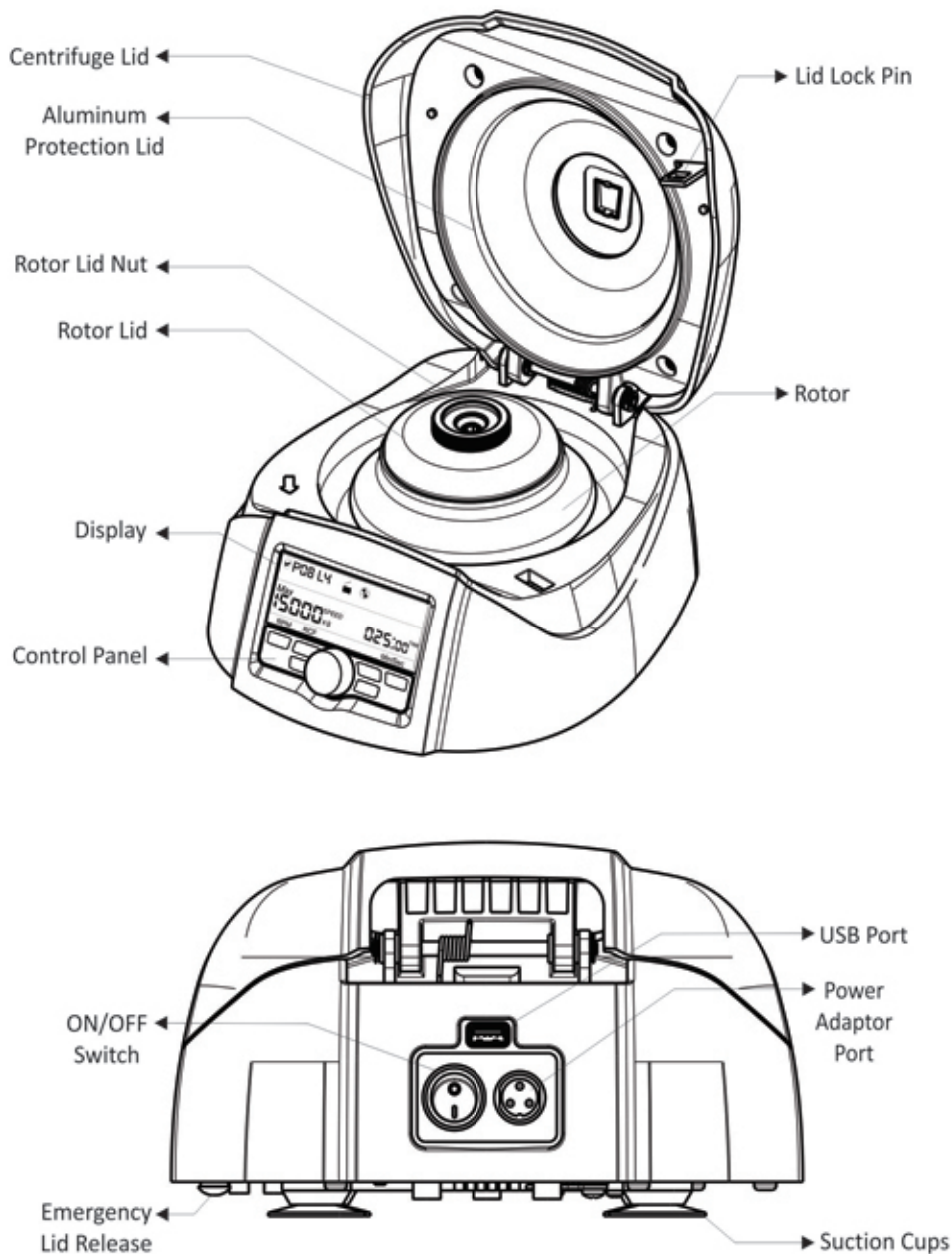

5. USER INTERFACE & DISPLAY

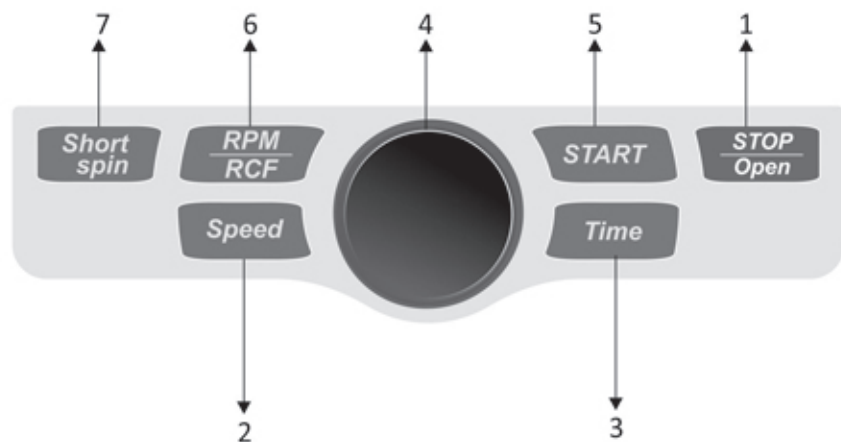

Item	Name	Function
1	STOP/OPEN BUTTON	Press button to STOP the ongoing operation. Lid opens automatically, after rotor comes to a stop.
2	SPEED BUTTON	Press button to select SPEED mode. Then rotate SETTING KNOB to set desired run SPEED.
3	TIME BUTTON	Press button to select TIME mode. Then rotate SETTING KNOB to set desired run TIME.
4	SETTING KNOB	Use to set speed and time values. Rotate the knob clockwise to increase and anti-clockwise to decrease values.
5	START BUTTON	Press button to START running centrifuge.
6	RPM/RCF BUTTON	Use to set/read RPM/RCF values.
7	SHORT SPIN BUTTON	Press & hold button after setting the required speed to run centrifuge for short time.

5. USER INTERFACE & DISPLAY

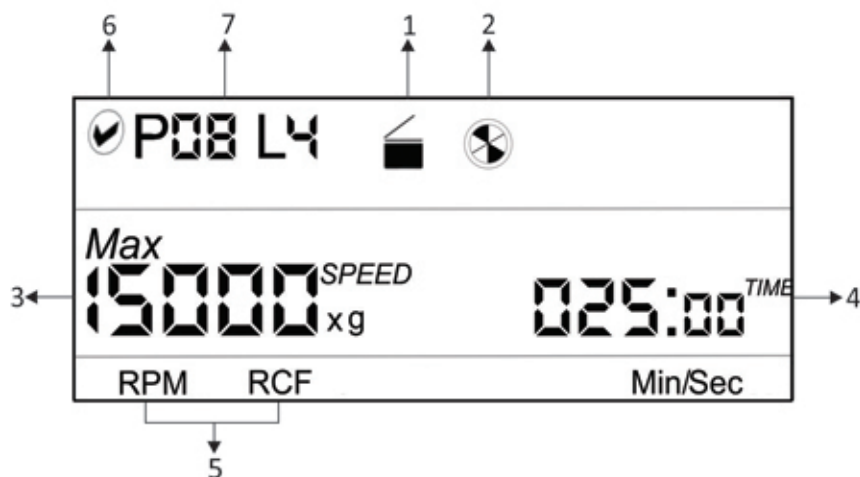







Item	Symbol	Description
1		Indicates lid status. Left image = lid close & Right image = lid open.
2		Indicates centrifuge status. When centrifuge is running the symbol rotates and when centrifuge is not running the symbol is stable.
3	<i>Max</i> 15000 ^{SPEED} xg	Indicates the speed value at which centrifuge is running. xg indicates the value in RCF mode.
4	025:00 ^{TIME} Min/Sec	The timer is a countdown timer. Indicates the time for which the centrifuge will run. Indicates the time in Min/Sec mode.
5	RPM/RCF	Indicate RPM or RCF mode and shows corresponding values.
6		Centrifuge is connected via software. When this mode is active, control panel buttons (except stop button) will be deactivated.
7	P08 L4	Indicates the specific program details being used. (Applicable in remote operation mode)

6. ROTOR INSTALLATION

6.1 ROTORS

Below table shows the rotors which are compatible with the centrifuge & its Max. RCF with different tubes & adaptors.

12 tubes rotor	1.5/2.0ml tubes	0.5ml/0.4ml Adaptor		0.2ml Adaptor
				
		0.5 ml	0.4 ml	
Max. Speed	15000	15000	15000	15000
Max. RCF	15596	12577	12074	10816

PCR strip rotor (Optional)	0.2ml PCR strip
	
Max. Speed	15000
Max. RCF	13080

NOTE: Always use recommended accessories for best result & product safety.

6. ROTOR INSTALLATION

6.2 ROTOR REMOVING AND REPLACING PROCESS

Upon reception of centrifuge, the rotor comes pre-installed. In case if you want to remove or replace rotor, follow the below mentioned procedure.

6.2.1 REMOVING ROTOR

1. Do not remove or loosen the rotor lid before attempting to remove rotor.
2. Using T - Allen Key, loosen the rotor nut by turning it anti-clockwise. Do not try to pull the rotor, rotor will come up automatically.
3. Once the rotor nut is loosen completely, pull up the rotor vertically.

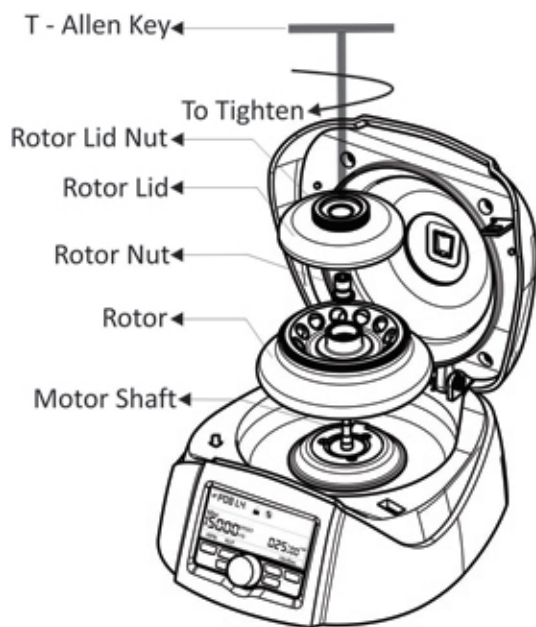

6.2.2 REPLACING ROTOR

1. To replace or install the rotor, take rotor and load vertically on the motor shaft.
2. Place the rotor nut in the center hole of the rotor onto the motor shaft.
3. Put T-Allen Key in rotor nut & turn clockwise to tighten and anti-clockwise to loosen rotor.

4. After properly fastening rotor, place rotor lid on the rotor lid nut with hand by rotating rotor lid nut clockwise.

Note: 1) Check the rotor is firmly tightened before running.

2) Do not remove or loosen the rotor lid before removing rotor.

6. ROTOR INSTALLATION

6.3 BALANCING THE ROTOR

1. Always balance the rotor before centrifugation. Following are symmetrical loading of centrifuge tubes to rotor.



2. The above is the correct method of loading the tubes in the rotor. The samples in the tubes should be of equal volume.
3. Symmetrical loading of tubes in the rotor is necessary. Otherwise vibration or imbalance can occur which can cause serious damage to the centrifuge.
4. If the tubes are not loaded symmetrically then the imbalance detector will cut off the running centrifuge for device & user safety. This will stop the centrifuge and Err 55 will be seen indicating tubes are not loaded symmetrically. To resume operation, load tubes symmetrically & restart the centrifuge.
5. Incorrect method of loading tubes in centrifuge rotor.



NOTE: *Incorrect method of loading tubes can lead to an accident.*

7. OPERATING THE CENTRIFUGE

7.1 SWITCH ON THE CENTRIFUGE

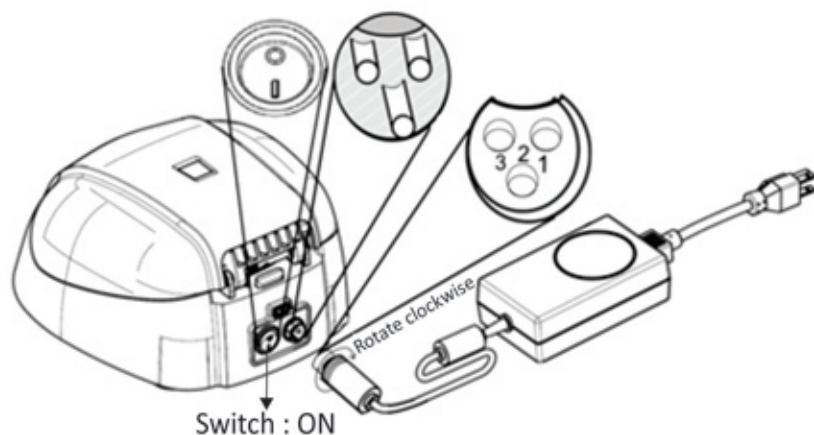

After connecting the power adaptor, switch ON the power mains & the switch at the rear side of the centrifuge. Make sure to check the rotor fitment before use. Centrifuge will not operate with open lid.

NOTE: Maintain a gap of 3 seconds between switch OFF and switch ON again. DO NOT switch OFF and ON again instantly.

7.2 SETTING SPEED AND TIME

After closing the centrifuge lid; press "SPEED BUTTON" to select speed setting. Now rotate the "SETTING KNOB" clockwise to increase the speed value and rotate anti-clockwise to decrease the speed value. The minimum and maximum speed of the centrifuge is 500 rpm and 15000 rpm respectively. You can speed up the speed value by rotating setting knob quickly.

1. Pressing the speed button "ONCE" will make the speed change in interval of 1000s. For example: if speed is 10000 rpm, then next speed will be 11000 rpm.

7. OPERATING THE CENTRIFUGE

2. Pressing the speed button "TWICE" will make the speed change in interval of 100s. For example: if speed is 10000 rpm, then next speed will be 10100 rpm.
3. Pressing the speed button more than 2 times will again start the process from point 1.
4. The input will be accepted if we leave the setting knob idle for 3 seconds. The value will blink five times to indicate acceptance.



The speed can be changed while the centrifuge is running. Press the speed button & follow above steps. Changing the speed between the ongoing centrifugation will run the centrifuge at updated speed for the rest of time as indicated by the timer.

Press "TIME BUTTON" to select time setting. Now rotate the "SETTING KNOB" clockwise to increase the time and rotate anti-clockwise to decrease the speed. The centrifuge timer set for run between 30 seconds to 999 minutes or operated in infinite time mode. Infinite timer will be indicated by

 in display. The minimum time setting is 30 seconds. The timer in the centrifuge is countdown timer and time in the display will be in "Min/Sec" mode. The same will showed on the display.

1. Pressing the time button "ONCE" will make the time change in interval of minutes. For example: if time is 005:00 (5 Mins 0 Sec), then next time will be 006:00 (6 Mins 0 Sec).
2. Pressing the time button "TWICE" will make the time change in interval of seconds. For example: if time is 005:00 (5 Mins 0 Sec), then next time will be 005:01 (5 Mins 1 Sec).
3. Pressing time button more than 2 times will start the process from point 1.
4. The input will be accepted if we leave the setting knob idle for 3 seconds. The value will blink five times to indicate acceptance.

7. OPERATING THE CENTRIFUGE

Press “START BUTTON” to start operation and press “STOP/OPEN BUTTON” to stop the ongoing operation. When the centrifuge is running the symbol “” will be rotating. Pressing the “STOP/OPEN BUTTON” will stop the operation as well as it will open the centrifuge lid automatically once the rotor comes to a stop. If the time gets over; the centrifuge will stop and lid will automatically open. When the centrifuge is not running the symbol “” will be stable. To open the lid without a run, press the stop/open button.

7.3 SWITCHING TO RCF DISPLAY

Press “RPM/RCF BUTTON” to change the mode from RPM to RCF (Relative centrifugal force). After pressing the button the display will show the speed in RCF. Maximum RCF speed of the centrifuge is 15596 x g. The system will automatically convert the values from RPM to RCF and vice versa.

7.4 SHORT SPIN CENTRIFUGATION

Press “SHORT SPIN BUTTON”: Short Spin Centrifugation is the feature for short/pulse run. It will run as long as the button is pressed. Set rotational speed prior to short spin as required. During short spin the timer will be in incremental mode. After releasing short spin button the time in the display will show duration of short spin.

7.5 OPENING CENTRIFUGE LID IN POWER FAILURE

Disconnect the centrifuge from the main supply. Wait until the rotor has come to a standstill (this may take longer time). Once the rotor has stopped, use any the tool to push down the emergency lid release cap. Insert the tool in the hole of emergency lid release cap and push down. This will open the centrifuge lid. After the centrifuge lid opens, release the emergency release cap back in the hole.

7. OPERATING THE CENTRIFUGE

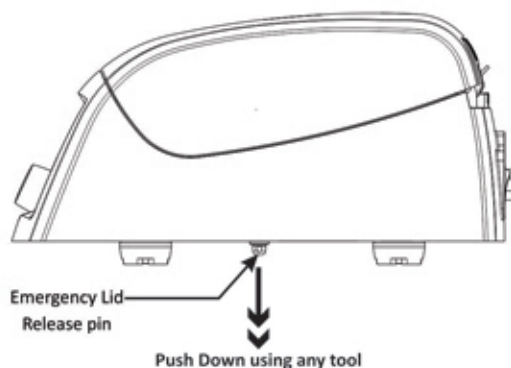

7.6 IMBALANCE DETECTION

The centrifuge is equipped with an imbalance detection safety feature. When the rotor is not loaded symmetrically, the imbalance detector gets activated and will cut off the centrifugation. The error "Err 55" will be shown on the display. First correct the imbalance load using method described in the balancing the rotor section (page no. 12) of this manual. After correcting the imbalance, switch OFF & switch it ON again. The values will be same as set before imbalance. The imbalance detection feature cannot be deactivated, as it is factory fitted.

8. REMOTE OPERATION & PROGRAMMING

For programming and remote operation the centrifuge needs to be connected to a computer.

8.1 SYSTEM REQUIREMENT

The GUI software and data logger file required the following minimum system requirement to operate:

Operation System: Windows® 7 with i3 Processor or more having 32 bit or 64 bit operating system and Windows® XP SP3.

Microsoft .NET framework 4 and Microsoft Office Excel 2007 or 2010 is required for operating GUI.

8.2 INSTALLING GUI SOFTWARE

Software CD is provided with the centrifuge kit. Install the software from the CD by running the setup file. After installation the GUI software icon and centrifuge data logger file will appear on the desktop.

8.3 CONNECTING USB CABLE

Connect one side of USB cable to back side of centrifuge and another side to computer USB port. Without USB connection the centrifuge will not operate through software. USB connection is shown below.

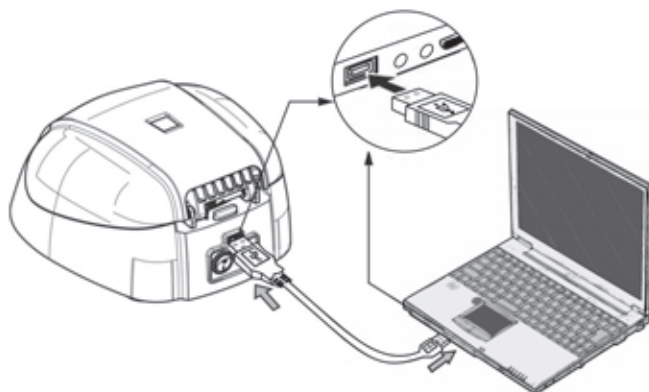

8. REMOTE OPERATION & PROGRAMMING

After connecting USB, display of centrifuge will show the USB connection. Top left symbol in centrifuge display indicates USB connection.

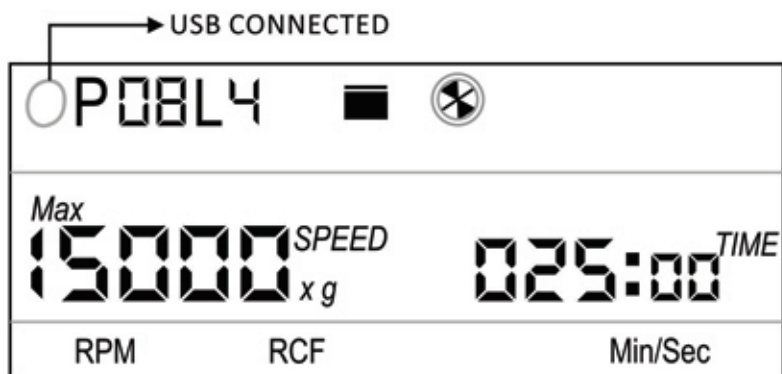

Once the USB cord is connected, centrifuge unit controls will be disabled. The centrifuge can now be run using the program. Only the "STOP/OPEN BUTTON" will work to STOP/OPEN the ongoing operation from the unit.

8.4 UNDERSTANDING THE GUI AND OPERATION

After installing the GUI software, open GUI software by double clicking the software icon. The following GUI window will open on computer screen.

GUI SCREEN

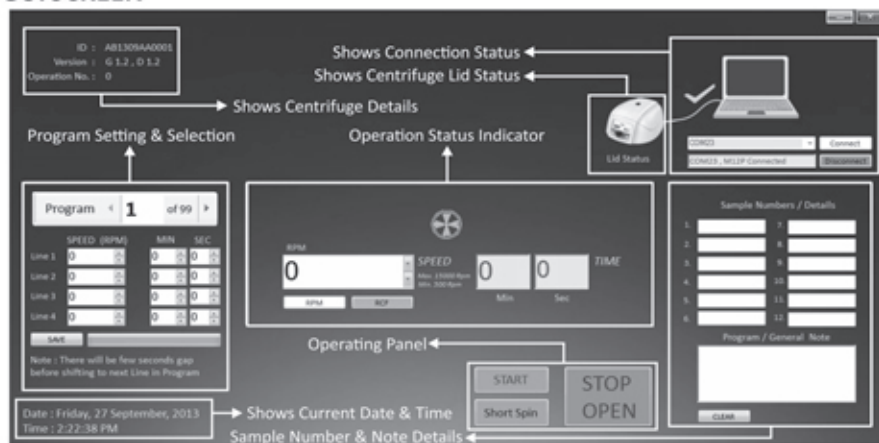

8. REMOTE OPERATION & PROGRAMMING

8.4.1. COM PORT CONNECTING AND DISCONNECTING



Once you connect the USB cable, the COM PORT for the centrifuge is detected automatically. Now click on the CONNECT button to connect shaker and computer for remote operation. After connection, the TEXT BOX will show “COM, M12P Connected” and the following change of diagram will appear in GUI screen.

NOTE: If any other device is connected after connecting centrifuge then the COM PORT of software gets update. So, select the centrifuge COM PORT from the COM PORT drop down box and click connect to reconnect the shaker.

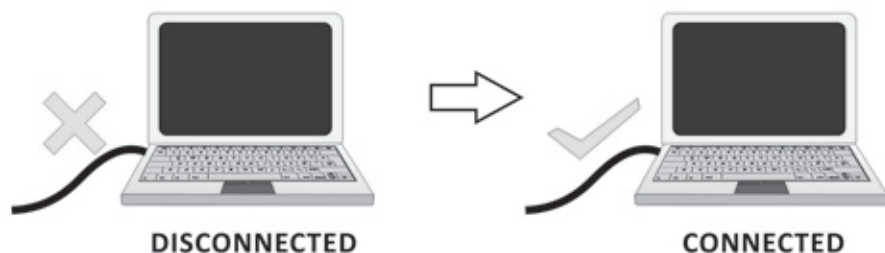

NOTE: Once the software is connected, the buttons on the centrifuge are deactivated & only stop button will operate.

8.4.2. CENTRIFUGE DETAILS



After centrifuge connection, the centrifuge ID and version will display in the GUI screen. The operation number shows the number of operation performed using the software.

8. REMOTE OPERATION & PROGRAMMING

8.4.3. SETTING A PROGRAM

Remote operation provides centrifugation with 99 programs and each of maximum 4 lines. It can be used to pre-set program for specific regular operations. User can save upto 99 programs according to their needs.

The same can be used for the cases mentioned below:

1. Run centrifuge for 2 minutes and 7 seconds with speed 15000 RPM
2. Then take a pause of 30 seconds
3. Then run centrifuge for 3 minutes and 22 seconds with speed of 7500 RPM
4. Then take a pause of 4 minutes and 15 seconds

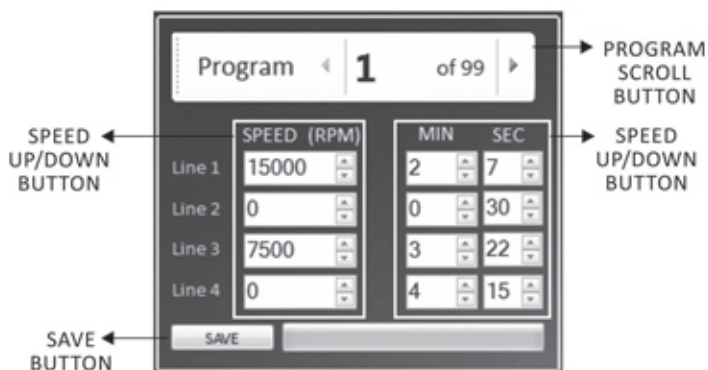

Note: There is delay of 8 seconds between all 4 lines.

After filling atleast one program line, the centrifuge display will change as shown below.

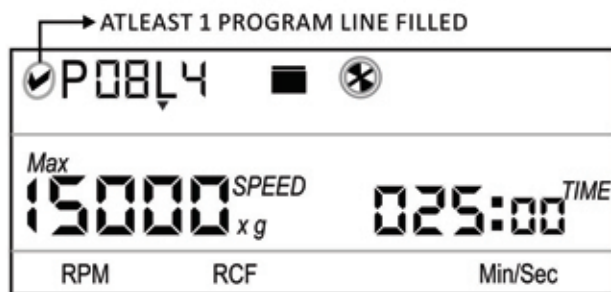

8. REMOTE OPERATION & PROGRAMMING

Click on the PROGRAM SCROLL BUTTON to select the required program out of total 99 programs you wish to set. User can save up to 99 programs. Start with the 1st line click on the SPEED UP/DOWN BUTTON to select value of the specific line of the program. Speed can be set only in RPM mode. Same way click on TIME UP/DOWN BUTTON to select time value of specific line of the program. Up to 4 lines of a program can be saved. Operation will always start from the 1st line. After changing speed and time for centrifugation according to user requirement click on SAVE button to save/set the program. Follow the same procedure for other lines of the program as needed.

8.4.4 PROGRAM NOTE AND SAMPLE NUMBERS

User can write the details of each sample used for centrifugation for their reference. User can also write General Note regarding the sample used, operation details or any other specific information which is worth mentioning according to user in General Note TEXT BOX as shown in below diagram. The data entered here would be saved in the data logger report.

The screenshot shows a software interface with two main sections. The top section is titled "Sample Numbers / Details" and contains 12 numbered input fields arranged in two columns. The first four rows have values: 1. 1202, 2. 2105, 3. 6598, 4. 1235, 7. 1202, 8. 2105, 9. 6598, 10. 1235. Rows 5, 6, 11, and 12 are empty. The bottom section is titled "Program / General Note" and contains a text box with the text "5, 6, 11, 12 has sample Number = 3205". Below the text box is a "CLEAR" button.

Click on the "CLEAR BUTTON" to clear the sample number and general note details of the program.

8. REMOTE OPERATION & PROGRAMMING

8.4.5 PRE-SET PROGRAM SELECTION AND OPERATION



Click on the PROGRAM SCROLL BUTTON to select the required pre-set program out of total 99 programs.



After selecting required program, click on START BUTTON to start the operation. Operation will start from 1st line of selected program. There is a delay or pause of 8 seconds between all 4 lines. Once operation of 1st line is over it will wait for 8 seconds to start the 2nd line operation. During the operation all the buttons on the device and boxes of the GUI will be disabled except STOP/OPEN button. When the centrifuge is running the symbol in the GUI  will rotate.

NOTE: *There is delay or pause of 8 seconds between all 4 lines.*

8.4.6 STOP OPERATION

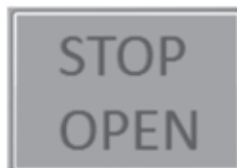

Click on STOP/OPEN BUTTON to stop the ongoing operation. Centrifuge lid opens automatically when the rotor comes to standstill. User can also stop the ongoing operation by pressing "STOP/OPEN" button in device. The lid status will be indicated on the GUI screen.

8. REMOTE OPERATION & PROGRAMMING

3.4.7 ACTIVE LINE SPEED DISPLAY



This SPEED UP/DOWN BOX is used to read speed value of active line of the program. For example: if line 3 of 46th program is running then this SPEED UP/DOWN BOX will display the speed value of line 3 of 46th program. It can be used to change the speed value of active line.

Click on RPM or RCF BUTTON to read speed value in RPM or RCF mode for active line.

3.4.8 ACTIVE LINE TIME DISPLAY



TIME TEXT BOX is used to read remaining time value of active line of the program. For example: if line 3 of 46th program is running then this TIME TEXT BOX will display the remaining time value of line 3 of 46th program. This is countdown timer.

3.4.9 SHORT SPIN CENTRIFUGATION

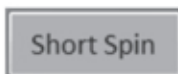

After setting required speed in SPEED UP/DOWN BOX click the SHORT SPIN BUTTON for short spin operation. The timer value in this mode is incremental in seconds. During short spin operation this TIME TEXT BOX will disable as this timer will convert to count up timer. Press STOP/OPEN BUTTON to stop short spin operation.

8. REMOTE OPERATION & PROGRAMMING

3.4.10 CENTRIFUGE LID STATUS



The above images will be display in the screen according to the status of lid. This will be the indication to the user regarding lid status.

3.4.11 CENTRIFUGE STATUS



This symbol shows the centrifuge status. When centrifuge is running the symbol rotates and when centrifuge is not running the symbol will be stable.

NOTE: Centrifuge will get connected to computer only if USB cord is connected to both centrifuge and computer. Proper selection of centrifuge COM PORT is necessary to enable the remote operation.

It is highly recommended not to use or work on any other application or do online work while GUI is operating.

8. REMOTE OPERATION & PROGRAMMING

8.4 DATA LOGGER

The remote operation comes with data logger features. All operations performed through the GUI will be saved in a excel sheet. With the help of data logger user can view and take a print out of previously performed operations.

User can access the data logger file from the desktop. Data logger file named as “Centrifuge_Data_Logger” will generate automatically on desktop of user’s computer once operation is performed.

The following type of operation details will saved in an excel sheet.

	A	B	C	D	E	F	G	H
7	Date : Friday, 19 July, 2013							
8	Time : 4:45:25 PM							
9	Centrifuge ID : AA1307B30001							
10	Version No. : G 1.2 , D 1.2							
11	Operation No. : 1							
12	S1:							
13	S2:							
14	S3:							
15	S4:							
16	S5:							
17	S6:							
18	S7:							
19	S8:							
20	S9:							
21	S10:							
22	S11:							
23	S12:							
24	Note :							
25	NORMAL Operation							
26	P : 1							
27	L : 1							
28	SET SPEED : 15000 RPM							
29	SET TIME : 2 Min And 51 Sec							
30	-----							
31	STOP TIME : 2 Min And 27 Sec							
32	Run TIME : 0 Hour And 0 Min And 24 Sec							
33	ERROR STATUS :							

Centrifuge_Data_Logger Sheet2 Sheet3

NOTE: The GUI software will not operate if “Centrifuge_Data_Logger” file is open. Ensure to close the log sheet before remote operation.

9. MAINTENANCE AND CLEANING

1. The rotor and the outside of the centrifuge should be cleaned regularly with a moist cloth.
2. Ensure that while cleaning the unit is not plugged in.
3. Wear protective gloves & safety glass while operating & cleaning the device.
4. The brushless motor in the centrifuge requires no routine maintenance. Any required service should be performed by authorized, qualified personnel only. Repairs performed by unauthorized personnel may void the warranty.
5. Always keep the centrifuge housing, rotor chamber, rotor and rotor accessories clean. All parts should be wiped down periodically with a soft cloth. For more thorough cleaning, use a neutral cleaning agent (Ph between 6 and 8) applied with a soft cloth. Excessive amounts of liquid should be avoided. Liquid should not come into contact with the motor.
6. After cleaning, ensure that all parts are dried.
7. Regularly cleaning of the rotor is important.
8. If the rotor chamber needs cleaning, clean with cloth or sponge moistened with a neutral detergent solution.
9. Do not place the rotor into the cleaning solution!
10. If corrosive, toxic or pathogenic bacteria are accidentally spilled in the rotor or rotor chamber, the centrifuge must be decontaminated thoroughly.

Warning! This product does not contain bio-seals as per IEC/EN/CSA 61010-2-20 and cannot provide any level of containment in case of a spill or release of toxic, radioactive, or pathogenic micro-organisms thus these materials are not recommended to be used in this product.

10. TROUBLESHOOTING

This centrifuge has a self – diagnostic function. If a problem occurs, an error/warning code will be displayed on the display screen and the operator can determine the malfunction with the warning code below.

ERROR	PROBLEM	SOLUTION
No display	No main power connection.	Power check & proper plug-in of mains cable at both ends.
	Power failure	Check the mains fuse of the lab.
	Improper connection.	Connect adaptor properly.
	Lid not closed correctly.	Close lid correctly.
	Error with lid closing and opening mechanism.	Contact service.
Err 55	Rotor not loaded symmetrically.	Load rotor symmetrically & restart centrifuge.
Centrifuge lid cannot be opened	Rotor is still spinning.	Wait for the rotor to come to a stop.
	Power failure	Emergency lid release after rotor stops
Centrifuge shakes during acceleration & exceptional running noise	Rotor not loaded symmetrically.	Load rotor symmetrically & restart operation
	Either a broken tube, damage to the rotor or motor is cause for run noise.	Replace broken tube. For damaged rotor/motor contact service representative.
	Rotor damaged.	Remove & change rotor
Display error	Loose connection of display.	Contact service representative.

10. TROUBLESHOOTING

ERROR	PROBLEM	SOLUTION
Err 1	Lid latch Limit switch is not pressed	Open lid and close it properly.
Err 52	Rotor Stucked	Turn OFF the centrifuge, Check & fit rotor properly & turn ON again.
Power tripping	Cable not fit properly.	Remove cable and connect properly.
Last run memory not displayed	Turing ON centrifuge immediately after turning it OFF.	Maintain 3 seconds gap Between switch OFF and switching ON again.
System gets hang	Electronics error.	Switch off centrifuge and then switch it ON again. If the error still shows, contact service representative.

IMPORTANT NOTE:

1. *If system gets hang or get hot due to over current, switch OFF & switch ON (restart) the centrifuge and check it again.*
2. *Maintain 3 seconds gap between switch OFF and switch ON. Instant ON-OFF can lead to a reset, erasing last run memory.*
3. *If motor gets hot due to which there will be fluctuation in speed value then allow centrifuge to get cold for atleast 30 minutes. Do not do any operation for 30 minutes*
4. *It is highly recommended not to use or work on any other application or do online work while GUI is operating.*
5. *The GUI Software will not operate if "Centrifuge_Data_Logger" file is open. Close the "Centrifuge Data Logger" file and open software for remote operation.*
6. *Do not use liquid with density higher than 1.2g/ml for full load operation.*

11. WARRANTY STATEMENT

This products is warranted to be free from defects in material and workmanship for a period of two (2) years from date of purchase. Your product will be duly repaired upon prompt notification in compliance with the following conditions :

This warranty is valid only if the product is used for its intended purpose and within the guidelines specified in this instruction manual. This warranty does not cover damage caused by accident, neglect, misuse, improper service, natural forces or other causes not arising from defects in original material or workmanship. This warranty does not cover any incidental or consequential damages, commercial loss or any other damages from the use of this product.

The warranty is invalidated by any non-factory modification, which will immediately terminate all liabilities on us for the products or damages caused by its use. The buyer and its customer shall be responsible for the product or use of products as well as any supervision required for safety. If requested the products must be returned to the distributor in well packed and insured manner and all shipping charges must be paid.

Some states do not allow limitation on the length of implied warranties or the exclusion or limitation of incidental or consequential damages. This warranty gives you specific legal rights. This warranty is given expressly in lieu of all other warranties, expressed or implied.

11. WARRANTY STATEMENT

The purchaser agrees that there is no warranty of merchantability or of fitness for any intended purpose and that there are no other remedies or warranties, expressed or implied, which extend beyond the description on the face of the agreement. This warranty is only applicable to the original purchaser.

The software is made available with the kit. It is designed to work on Windows XP SP3, Windows 7. The software should be used as explained in the user manual. The warranty does not cover the software failures due to issues in user system (computer or laptop).

Products received without proper authorization will not be entertained. All items returned for service should be sent postage prepaid in the original packaging or other suitable carton, padded to avoid damage. We will not be responsible for damage incurred by improper packaging.

All items returned for service should be set postage prepaid in the original packaging or other suitable carton, added to avoid damage.

This warranty is valid only if the warranty is registered with the supplier within 30 days from the date of purchase.

12. PRODUCT DISPOSAL

In case the product is to be disposed of, the relevant legal regulations are to be observed.

Information on the disposal of electrical and electronic devices in the European Community

The disposal of electrical devices is regulated within the European Community by national regulations based on EU Directive 2012/19/EU on waste electrical and electronic equipment (WEEE). According to these regulations, any devices supplied after 13.06.05 in the business to business sphere, to which this product is assigned, may no longer be disposed off in municipal or domestic waste. They are marked with the following symbol to indicate this.



As disposal regulations within the EU may vary from country to country, please contact your supplier if necessary.



Landbrugsvej 10 | DK 5260 | Odense S | Denmark

Tlf +45 6613 6140 | Fax +45 6613 2770

www.capp.dk | info@capp.dk